

CHROM. 6848

AN APPARATUS FOR THE QUANTITATIVE ANALYSIS OF VOLATILE COMPOUNDS IN URINE*

ARTHUR B. ROBINSON, DAVID PARTRIDGE, MARTIN TURNER, ROY TERANISHI
and LINUS PAULING

Institute of Orthomolecular Medicine, Menlo Park, Calif. (U.S.A.)

(Received April 24th, 1973)

SUMMARY

A completely automated apparatus for the quantitative analysis of volatile compounds in urine vapor and breath is described in detail. More than two-hundred compounds are shown to be routinely measured in urine vapor, and the application of the apparatus to orthomolecular diagnosis is discussed.

INTRODUCTION

It has been suggested that the treatment of disease should be carried out by adjustment of the concentrations of substances in the human body so as to duplicate those concentrations which correspond to optimum health and that this adjustment should be carried out whenever possible by the administration of compounds normally found in the human body¹. The administration of the right molecules in the right amounts is called "orthomolecular therapy". It has further been suggested that a quantitative assessment of the state of molecular health of the human body, "orthomolecular diagnosis", might be made in a practical way by the quantitative analysis of the normal constituents of human urine followed by a simple type of computerized pattern recognition². Human urine has been found to contain several hundred normally volatile compounds that are easily separated by gas-liquid chromatography^{3,4}. An apparatus has been described for the separation of these compounds in a qualitative manner⁵. Duplicate analyses on this apparatus showed wide quantitative and qualitative variations and were not suitable for use in orthomolecular diagnosis. We have, therefore, devised an apparatus that is suitable for the routine quantitative analysis of about 200 volatile constituents of human urine.

APPARATUS

Figs. 1-6 illustrate the design of the apparatus, Fig. 7 shows a typical chromatogram of human urine volatiles obtained with the apparatus, and Fig. 8 shows the quantitative reproducibility of the apparatus in routine operation.

* Contribution No. 4 from the Institute of Orthomolecular Medicine, 2700 Sand Hill Road, Menlo Park, Calif. 94025, U.S.A.

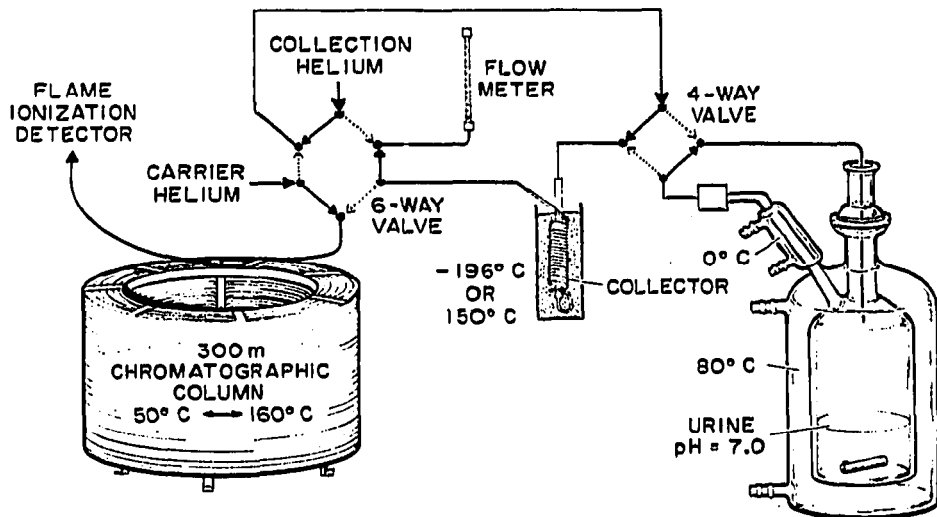

Fig. 1. Diagrammatic representation of one of the four urine vapor systems in the chromatographic apparatus.

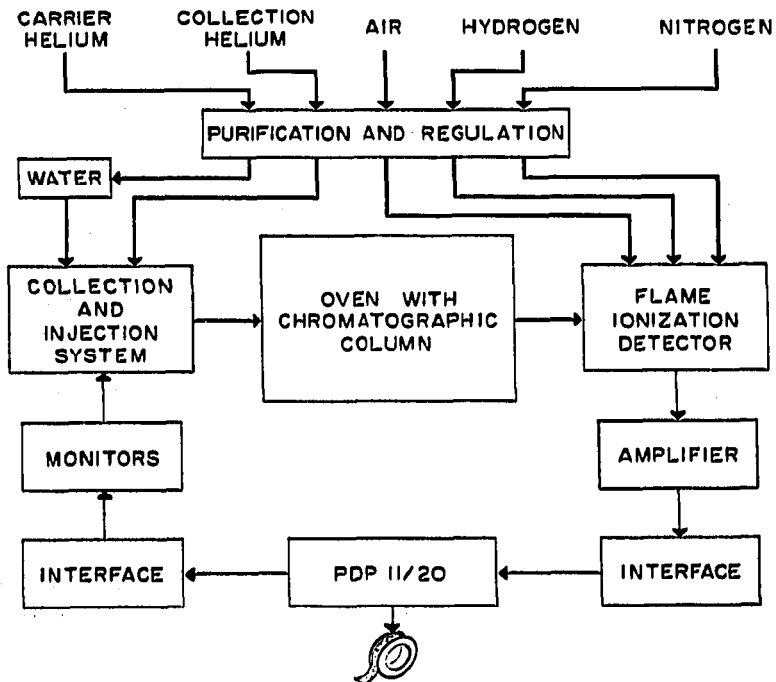

Fig. 2. Block diagram of the chromatographic apparatus.

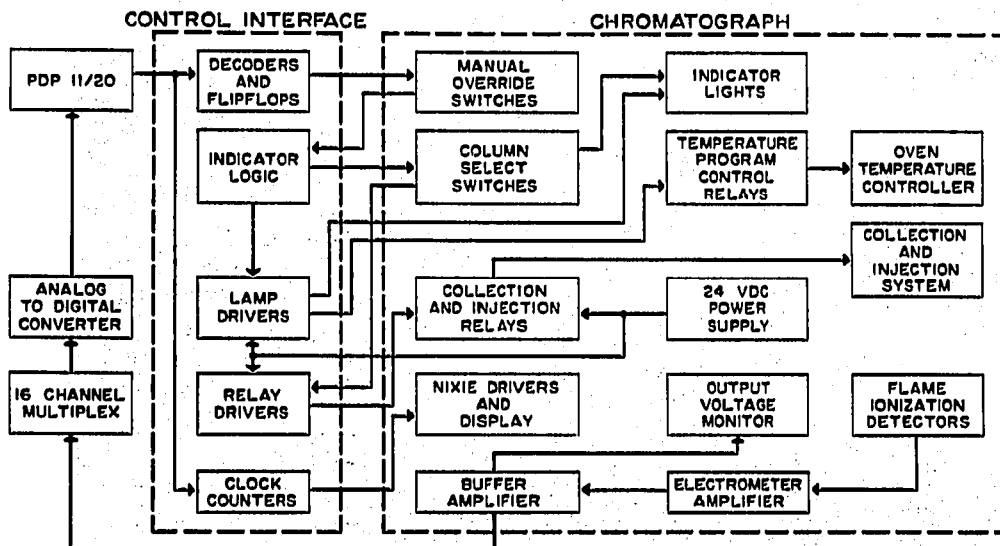

Fig. 3. Block diagram of the automation of the apparatus.

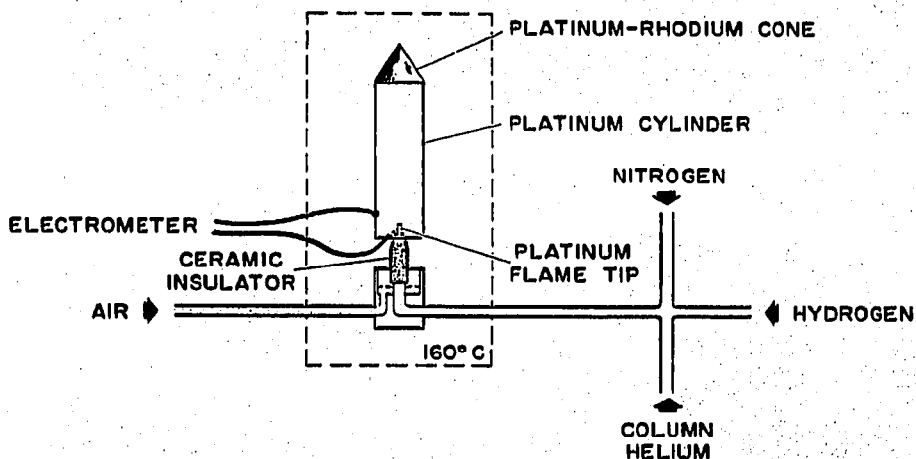

Fig. 4. Diagrammatic representation of one of the four flame ionization detectors in the chromatographic apparatus.

The chromatographic apparatus is 2.0 m long, 1.8 m high and 1 m thick. A 50-ml sample of urine, 19.65 g of KH_2PO_4 and 30.35 g of Na_2HPO_4 are placed in each of the four sample bottles and a key is depressed on the teletype of the PDP11/20 computer. The entire analysis is then carried out by the apparatus without any manual operations. A time of 6 h is allowed for each analysis, although this time can be shortened considerably with some loss of resolution.

GAS PURIFICATION AND FLOW REGULATION

Helium carrier gas

Ordinary reagent-grade tank helium passes through a Matheson Model IL-590

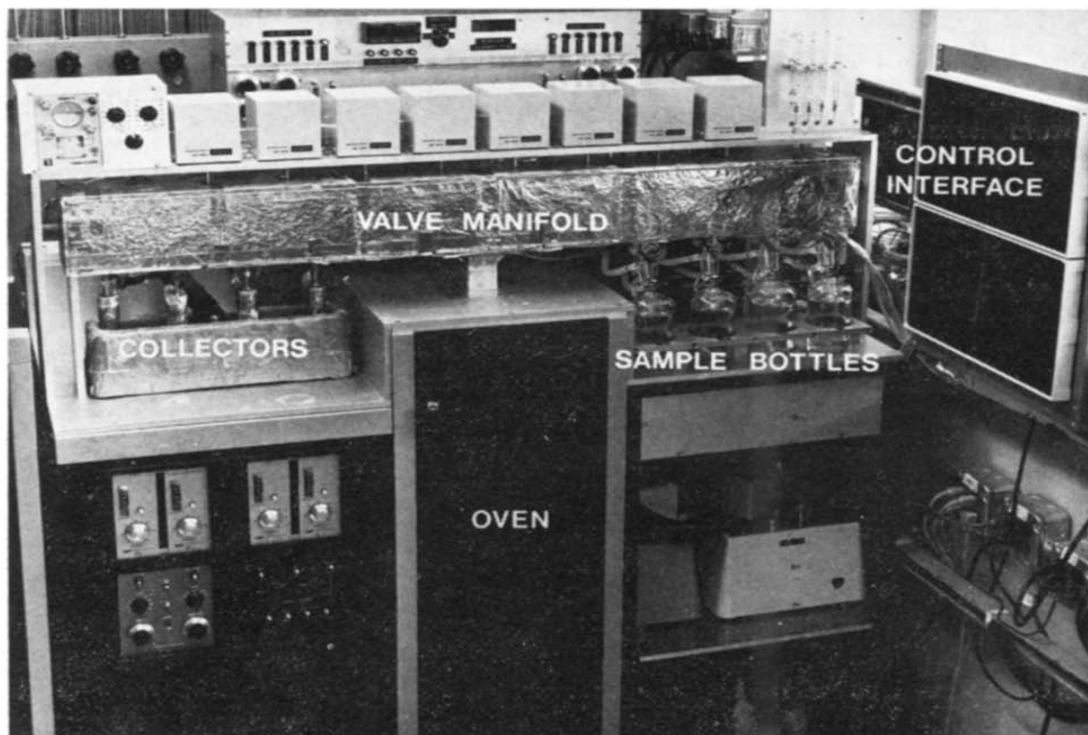

Fig. 5. Front view of the chromatographic apparatus.

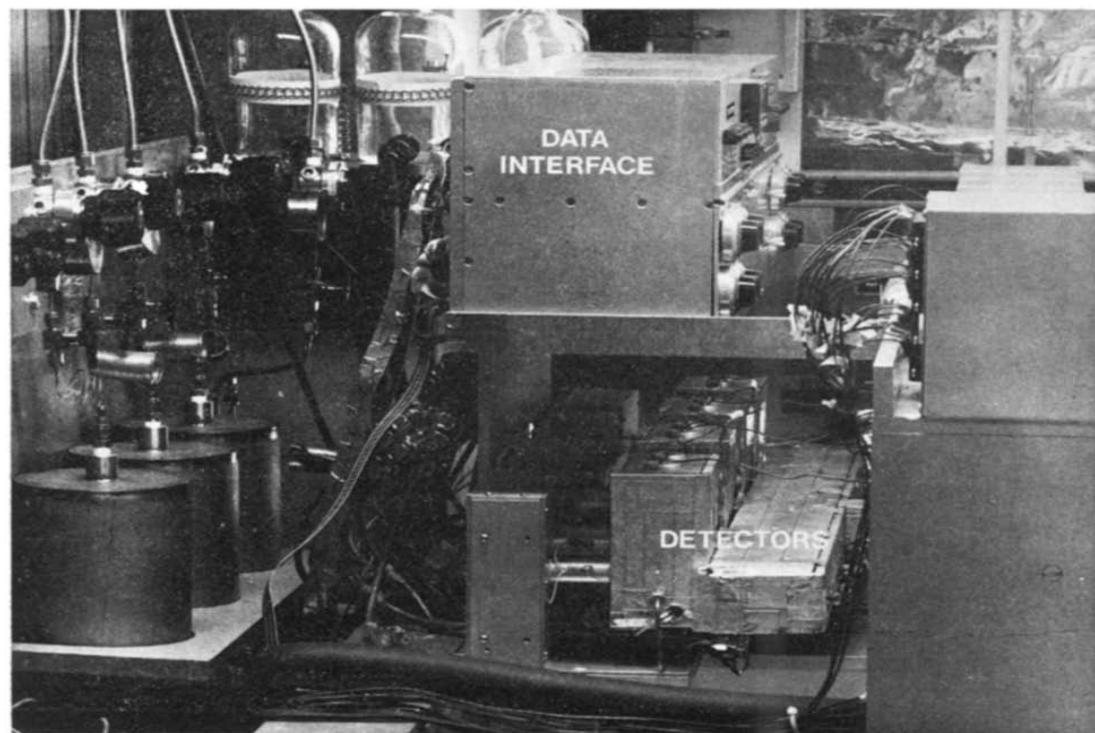

Fig. 6. Side view of the detectors.

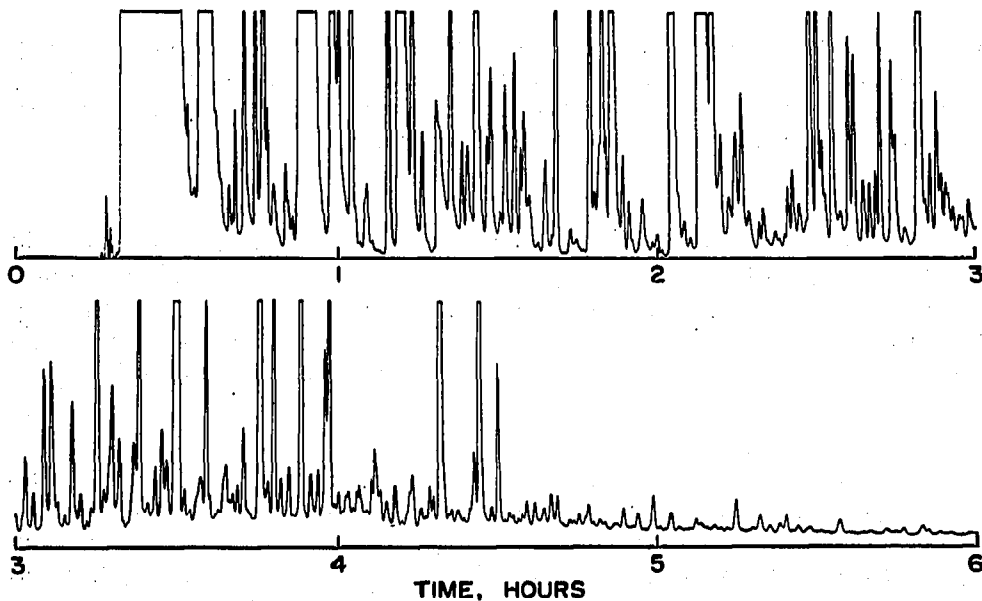

Fig. 7. Sample chromatogram of urine vapor from 50 ml of urine from a human subject with spinal cerebellar degeneration. The off-scale peaks were integrated correctly by the PDP 11/20 computer, as the chromatograph dynamic range is about 10^5 .

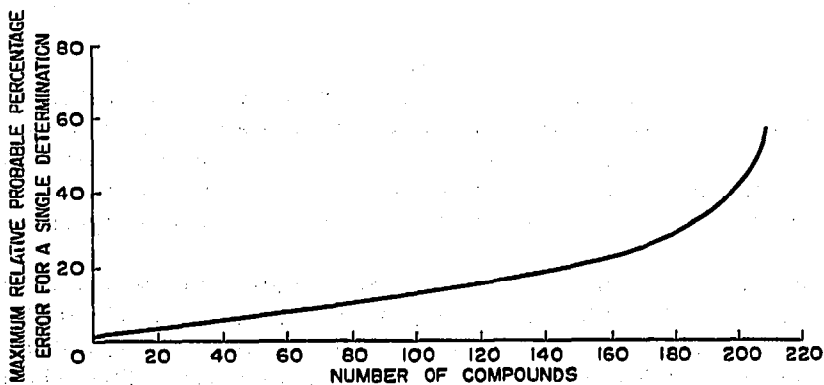

Fig. 8. Accuracy of a single sample analysis by the apparatus.

gas pressure regulator and into a 9.525-mm O.D. stainless-steel (SS) supply line that is maintained at a pressure of 200 p.s.i. The helium then passes through a Veriflo 41100061 balanced pressure regulator, a Whitey PTFE ball valve and a 2000-ml Con Val Inc. 8 HD 2000 SS cylinder that is maintained at 400° . The bottom half of the cylinder contains 1000 cm^3 of granulated copper, and the top half contains 1000 cm^3 of copper oxide wire in short pieces. The helium then passes into a 15-cm high and 10-cm diameter SS jacketed cylinder that is half filled with water and maintained at 20.0° . Then the helium passes through a 2.5-m length of 0.25-mm SS tubing and into the chromatograph.

Helium collection gas

This helium is supplied by a separate, but identical, 9.525-mm O.D. supply line as described above. It passes through an identical Veriflo regulator and Whitey valve. Then it passes through a 2.5-m length of 0.25-mm diameter SS tubing restrictor, a Cu-CuO purifier as described above and into the chromatograph.

Detector hydrogen

Ordinary tank hydrogen passes through a Matheson pressure regulator and then through a Serfass palladium-silver alloy filter Model C-50D hydrogen purifier. It then passes through a 9.525-mm O.D. SS supply line, a Veriflo regulator, a Whitey valve and a 2.5-m restrictor as described above. The hydrogen then passes through a 30-cm high and 15-cm diameter SS surge tank and into the chromatograph.

Detector air

Compressed air at a pressure of 66 p.s.i. passes through a Matheson IL-590 pressure regulator and then through a Hankison E10-T non-cycling air-drier with a No. 501 condensate trap. The air then passes through three consecutive 55-cm high and 15-cm diameter SS cylinders filled with 8-12 mesh coconut activated charcoal and then through four consecutive MSA 81857 mine safety filters. Then the air passes through a 32-cm high and 20-cm diameter SS surge tank and into a 9.525-mm O.D. supply line as described above. The air then passes through a Veriflo regulator and Whitey valve as described above, a 25-cm long, 0.25-mm diameter restrictor, a 30-cm high and 15-cm diameter SS tank and into the chromatograph.

Detector nitrogen

Ordinary reagent-grade tank nitrogen passes through a Matheson pressure regulator and into a 9.525-mm O.D. SS supply line as described above. The nitrogen then passes through a Veriflo regulator, a Whitey valve and a 2.5-m restrictor, as described above. Then the nitrogen passes through a 30-cm high and 15-cm diameter surge tank and a Cu-CuO purifier as described above and into the chromatographic apparatus.

Inside the apparatus, the gases are divided into 36 streams. There are four collection helium streams and eight streams of each of the other gases. Each of the air streams passes through a 25-cm, 0.25-mm diameter SS restrictor and each of the other gas streams passes through a 2.5-m, 0.25-mm diameter restrictor. The gases then pass through 3.175-cm O.D. SS lines and into their respective columns, collection bottles or flame ionization detectors. The 36 restrictors are housed in a 150 × 20 × 10 cm aluminum box with 12.7-cm thick walls, and the room temperature around the box is maintained at $21 \pm 2^\circ$.

The Veriflow regulators are adjusted to individual settings within the range 30-50 p.s.i. in order to give the desired flow-rates in the chromatograph. These flow-rates are: helium carrier gas at 28 cm/sec or about 14 ml/min at the detectors from a 300-m column; helium collection gas at 25 ml/min; detector hydrogen at 60 ml/min; detector air at 400 ml/min; and detector nitrogen at 50 ml/min. All gas lines in the chromatograph are made of stainless steel and all connections are made with stainless-steel Swageloks.

URINE VAPOR COLLECTION

The urine vapor collection and injection into the chromatographic column are automated by means of four Carle Model 5511 Minivolume four-way valves and four Carle Model 2021 Microvolume six-way valves. All eight valves are fitted with Carle Model 4200 automatic valve activators. Before urine vapor collection, the four-way valves are set in the position indicated by the solid lines in Fig. 1 in order to isolate the urine bottles from the helium collection gas stream.

The urine bottles, made of glass, are shaped as shown in Fig. 1, with a volume of 200 ml. The outer dimensions of the 80° jacket are height 15 cm and diameter 8 cm. The 0° jackets are 6 cm long and have an I.D. of 1 cm. The ball joints at the tops of the bottles contain a Viton O-ring and connections between the bottles and the collection helium inlet supplies in the valve manifold are with 3-m lengths of coiled 0.75-mm I.D. SS tubing. These tubes are press-fitted into the upper halves of the ball joints by means of PTFE cylinders. The 0° condensers are connected to the valve manifold by 10-cm lengths of 2-mm diameter PTFE tubing with Chromatronix connectors on the bottle ends and Swagelok connectors on the valve manifold ends. The 0° condensers remove most of the water vapor from the urine vapor without removing the volatile organic compounds. This is possible because the organic compounds are present in such small amounts and have such a low thermodynamic activity that they do not condense in the 0° condensers. Small amounts of organic compounds dissolve in the water that is trapped by the condenser and are recirculated through the 80° bottle. These small amounts do not seem to seriously diminish the quantitative reproducibility of this apparatus. The urine bottles are made by Paul V. Yeager, 414 J Street, Chula Vista, Calif., U.S.A.

The urine vapor collectors are 8 cm high and 4 cm in diameter. Each has a 6.4-mm diameter inlet tube wrapped with a coil of 1.6-mm diameter outlet tube. An iron-constantan thermocouple is wired on to the coils and the coils are imbedded in tin-lead alloy with a melting-point of 200°. The alloy in each collector is surrounded by a copper cylinder. The cylinder is wrapped with several layers of asbestos paper and glass tape and a continuous piece of nichrome ribbon is wound between the layers. The nichrome ribbons and the thermocouples are connected to four API Type-J temperature controllers and four API Model 4010 30-A power-packs. The four controllers are connected directly to the valve manifold and are surrounded by an insulated trough that can be filled with liquid nitrogen through a Valcor Model 94 C.19 C 6-R solenoid valve and insulated tube. The trough is shown dropped down in Fig. 5 so that the collectors can be seen. The trough can keep the collectors at -196° for a period of 1.5 h after a single filling of liquid nitrogen. The nichrome ribbon length and resistance are adjusted so that the API controllers change the collector temperatures from -196° to +150° during a time of 200 sec after the API controllers are activated.

After the bottles have been filled and the collectors have been brought to -196°, the four-way valves are turned to the position indicated by the dotted lines while the six-way valves remain in the position indicated by the solid lines. The urine is stirred vigorously by magnetic stirring bars while helium at a flow-rate of 25 ml/min is introduced above the urine solution and passed through each urine bottle for 1 h. The Varian Model 37-000393-00 helium flow meters allow a qualitative check of

this flow-rate. After the full 1.5 l of helium has passed through the bottles, the four-way valves return to the position indicated by the solid lines and the urine vapor collection is complete.

URINE VAPOR INJECTION INTO THE CHROMATOGRAPHIC COLUMN

After the urine vapor collection has been completed, the six-way valves turn to the position indicated by the dotted lines in Fig. 1 and the API temperature controllers are activated. The four-way valves remain in the position indicated by the solid lines. After 10 min, the six-way valves return to the position indicated by the solid lines and the urine vapor injection is complete. The collectors remain at 150° until the next urine vapor collection cycle is initiated.

CHROMATOGRAPHY

The chromatography is carried out in open-tubular 300-m 0.76-mm I.D. stainless-steel columns coated with SF-96-50 silicone oil that contains 5% of Igepal. The columns are coated by the method of Mon⁶. The oven and oven temperature controller are from a Varian 2100 chromatograph, and the oven has been modified so as to improve the air flow around the columns, which are wound on 16-cm diameter and 19-cm high inner frames. The outer diameter of the columns is 24 cm. Two columns are wound on each frame, so that eight 300-m columns are present in the oven. The Varian 2100 oven temperature controller has been modified for computer control. The chromatographic apparatus contains eight columns, eight flame ionization detectors and only four urine vapor injection systems, because it was designed so that each analytical column would have a reference column. However, such care was used in temperature control, detector design, gas purity, cleanliness of assembly and column preparation that the reference columns are unnecessary. We accordingly have four spare columns and four spare detectors in the chromatograph, which improve the efficiency of the chromatograph during routine operation.

We are at present allowing 6 h for the chromatography of urine volatiles, which allows the maximum resolution of compounds by the chromatograph. Preliminary experiments have indicated that the analysis time can be considerably shortened with only moderate loss of resolution by use of shorter columns and higher temperature program rate. A 1-h analysis time may soon become practical by means of this same chromatograph fitted with an improved computer-controlled oven, smaller self-washing urine bottles and an improved integration program in the calculation computer that can integrate incompletely resolved peaks more accurately.

At present, we inject the urine volatiles into the chromatograph with the oven at 50°. 30 min after the start of the injection cycle, the oven temperature begins to increase at the rate of 0.5°/min. When a temperature of 150° is reached, the temperature program stops and the oven temperature remains at 150° for the remainder of the 6-h period. After 6 h, the oven door must be opened manually so as to allow a rapid return to 50° before the next injection cycle is started.

FLAME IONIZATION DETECTORS

We have made some changes in flame ionization detector design to improve

the sensitivity and reproducibility of this chromatograph (see Figs. 4 and 6). Most importantly, a 5-cm high and 2-cm diameter platinum cylinder topped by a platinum-rhodium mesh cone is used as an ion collector. The ion collector is held together by spot welds. Air is supplied through a stainless-steel disc with eight small concentric holes. A ceramic insulator is positioned between the detector base and the platinum flame tip and all tubes in the detector base are made from single pieces of tubing all the way to the outlets. Great care is exercised in the manufacture and cleaning of the detectors. These detectors are so similar in sensitivity that the linearity of response with change in sample amount is excellent even when different amounts of sample are put into each of the four different columns and detectors and then compared on the same graph. Linearity of response for 14 typical urine vapor compounds has been shown down to 10^{-9} g with the collection and injection system described above. The limit of detectability seems to be about 10^{-11} g. Electronic noise in our circuits from chromatograph to computer seems to be the major limiting factor. We have not tested the linearity and sensitivity below these amounts of urine vapor compounds, because there are so many constituents of human urine vapor that this chromatograph is limited by its resolution and not its sensitivity.

The detectors are contained in $14 \times 10 \times 5$ cm boxes of 4-mm thick aluminum. The cylinders and flame tips are connected by platinum wires to 0.6-mm threaded steel rods that extend through the insulators and into $15 \times 15 \times 5$ cm, 4-mm thick aluminum boxes that contain the solid state electrometers (Fig. 6). Two complete detectors are housed in each of these boxes, isolated by aluminum center plates.

TEMPERATURE CONTROL

Temperatures are carefully controlled and monitored throughout the chromatograph. There are 35 iron-constantan thermocouples set at various points in the manifolds, liquid temperature control lines, detector boxes and injectors. These are switched into a Thermoelectric Minimate meter and checked occasionally.

All valves and gas streams are located inside boxes made from 12.7-mm thick aluminum with 50-W and 100-W cartridge heaters inside holes drilled normal to the 12.7-cm thick edges. Detector temperatures are maintained by similar plates attached to the detector bases. The outer dimensions of the main valve manifold are $140 \times 16 \times 10$ cm and of the detector manifold $80 \times 9 \times 4$ cm. Similar small box manifolds connect the large manifolds with each other and with the oven of the chromatograph. The cartridge heater temperatures are maintained by 14 LFE Model 232 temperature controllers that are attached to 14 of the thermocouples. The manifolds and detectors are covered with 3-mm thick Fiberfrax carborundum insulation and aluminum tape. The 20° water saturator, 0° urine water vapor condensers and 80° urine bottles are maintained at their respective temperatures by three Haake type FE temperature control baths. The 20° and 0° baths are connected to two Polyscience KR 70 chillers through coolant coils in the Haake baths. The temperature-controlled liquids are pumped through 1.5-cm I.D. tubes and manifolds and through their respective parts of the chromatograph. The buffer amplifiers and automation monitoring electronic circuits are in a $75 \times 23 \times 20$ cm box of 3.2-mm thick aluminum above and behind the hot manifolds, and a Fiberfrax and aluminum insulating board is positioned between these electronic circuits and the hot manifolds. The automation

control interface is contained in a $53 \times 53 \times 30$ cm box on the right-hand side of the chromatograph (see Fig. 5), far away from the hot manifolds.

CHROMATOGRAPH AUTOMATION

All operations of the chromatograph are performed automatically by the PDP 11/20 computer (see Figs. 2 and 3), except for opening the oven door and washing the urine bottles with phosphoric acid and water between urine samples. We have now completed but have not installed an automatic bottle washing system, and we are designing an improved oven for the chromatograph.

The chromatograph automation and data collection are illustrated in Fig. 3. Digital Equipment Corporation (DEC) K-series logic is used throughout. K161 decoders, K206 flip-flops, K683 lamp drivers and K650 relay drivers are used. The indicator logic has K134 inverters and K123 "AND" gates, and the elapsed time clock has K210 counters and K671 Nixie drivers and display. The collection and injection relays are Potter and Brumfield Model KRP-5D general-purpose relays and the temperature program control relays are Magnecraft 132 MPCX4 mercury-wetted reed relays. The electrometers use Analog Devices Model 310 electrometer amplifiers and are constructed with careful attention to shielding and noise suppression.

The buffer amplifiers are Philbrick Nexus Model 1021 operational amplifiers. Both the positive and negative electrometer amplifier outputs are connected to the buffer amplifier inputs through two-stage RC filters with a cut-off frequency of 30 Hz. The output of each buffer amplifier is connected to the multiplex through a single two-stage RC filter with a cut-off frequency of 1 Hz.

The multiplex is constructed with DEC K-series logic. It can read each of 16 channels at rates between 240 and 7.5 readings/min. Faster rates are available when fewer channels are used. The maximum sample-rate on a single channel is 3840 samples/min. We have found that a reading-rate of 15 readings/min is sufficient for 6-h chromatograms. Analog-to-digital conversion is carried out by a Hewlett-Packard Model 3480 B automatic ranging digital voltmeter, which is interfaced to the PDP 11/20 computer through a DEC Model DR-11A general device interface. The computer is equipped with a dual DEC tape transport and programmed to store the chromatograms on either of the two tape units. The same PDP 11/20 computer controls all of the chromatograph automation and collects data from nine other chromatographs in the laboratory in addition to the four channels of the urine vapor chromatograph.

Chromatogram peak integration and retention time determination were originally performed by the above PDP 11/20 computer. We now perform integration, peak matching and various statistical pattern-recognition procedures with a second PDP 11/20 computer with DEC tape and a DEC 1.2-million word moveable head disc. There are no strip chart recorders in the laboratory. Chromatograms are plotted for visual display by means of a Zeta Model 100 plotter attached to the PDP 11/20 computer. These plots are not needed for our calculations. All chromatograms are permanently stored on DEC tape for future reference. A description of these computer programs and our pattern recognition procedure will be published elsewhere.

ANALYTICAL REPRODUCIBILITY

Although up to 350 compounds can be counted in a single analytical chromatogram, only about 200 compounds are routinely measured by the apparatus. The remaining compounds are not present in most urine samples, are inadequately resolved, are inadequately integrated and matched by the computer, or are lost in the urine vapor procedure in such a way that there are large errors in their measurement. The performance of such an apparatus should be evaluated in a quantitative way in routine use. Fig. 8 shows such an evaluation of this chromatograph in a manner that we suggest is more meaningful than the usual display of two chromatograms of the same sample or blanket statements about percentage reproducibility. The repeated analyses of a single human urine sample for this graph were performed at various times during routine operation. The percentage probable error for a single determination was calculated by the equation

$$\text{Probable error (\%)} = 67 \sqrt{\frac{\sum_{i=1}^n (\bar{\chi}_i - \chi_i)^2}{n-1}}$$

Where $\bar{\chi}_i$ is the mean of n determinations of χ_i and χ_i is the area under the χ th peak for the i th determination. Each χ_i was normalized by division by the sum of the area of most peaks in the chromatogram. Peaks with an area of 5% or more of the area of the sum of all peaks in the chromatogram were not used in the calculation of the sum for normalization.

For a given compound, there is a 50% chance that a single analysis will give a value within the calculated percentage probable error of the correct value. Fig. 8 shows that the expected errors increase as more peak areas are included in the set of peak areas that are reported by the computer.

DISCUSSION

We have constructed a fully automated apparatus for the routine quantitative analysis of about 200 normally occurring compounds in human urine vapor. The apparatus at present carries out an analysis every 1.5 h by means of four chromatographic columns, each of which performs one analysis in 6 h. We are using the machine to develop diagnostic procedures for various human diseases and are making changes in the machine that should reduce the routine time considerably. Even with the present long analysis time, the machine is economically suitable for use in preventive medicine, as no sample preparation and little operator time are required. This machine is also suitable for breath analysis³, but at present it is not being used for this purpose.

REFERENCES

- 1 L. Pauling, *Science*, 160 (1968) 265.
- 2 A. B. Robinson and L. Pauling, *Orthomolecular Psychiatry*, Freeman, San Francisco, 1973.
- 3 L. Pauling, A. B. Robinson, R. Teranishi and P. Cary, *Proc. Nat. Acad. Sci. U.S.*, 68 (1971) 2374.
- 4 A. Zlatkis and H. M. Liebich, *Clin. Chem.*, 17 (1971) 592.
- 5 R. Teranishi, T. R. Mon, A. B. Robinson, P. Cary and L. Pauling, *Anal. Chem.*, 44 (1972) 18.
- 6 T. R. Mon, *Res. Develop.*, 22, No. 12 (1971) 14.